

TWO-WIRE BUS APARTMENT SYSTEM

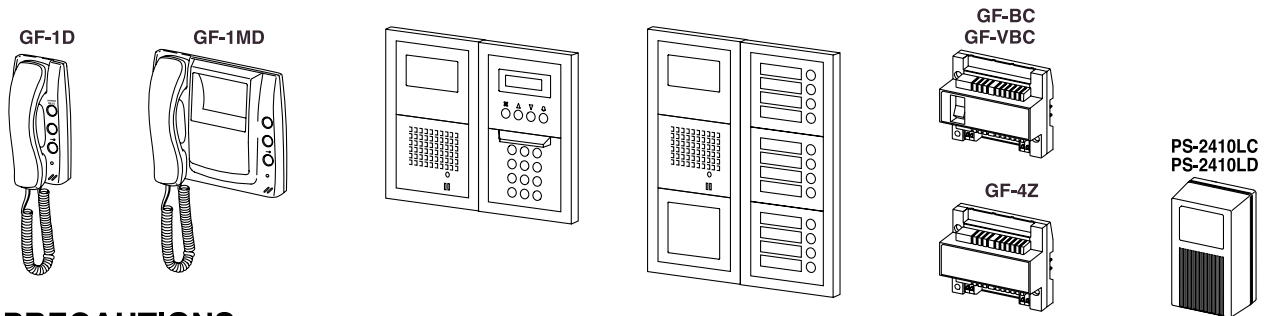





GF SYSTEM

INSTALLATION MANUAL







PRECAUTIONS

⚠ WARNING (Negligence could result in death or serious injury to people)

1. These devices are electrical. Wiring must be performed by qualified personnel. 
2. Do not modify or alter the equipment. 
3. Do not connect any power source other than specified to terminals +, -, nor install two power supplies in parallel to single input. Doing so may cause fire or damage the unit. 
4. The equipment must not be exposed to water or any other liquid. 
5. Make sure wires are connected properly before plugging the power supply into an electrical outlet. 
6. AC outlet must be away from moisture and dust. 

⚠ CAUTION (Negligence could result in injury to people or damage to property)

1. Do not manually hold down hook knob on GF-1D or GF-1MD. If called, call tone sounds very loud near your ears, and could cause your hearing damage. 
2. Do not install or make any wire terminations while power supply is plugged in, or it could cause electrical shock or damage the unit. 
3. Mount the intercom on wall in a convenient location, but not where it could be bumped or jarred. 
4. Do not install the unit in any of the following locations, as it may cause the system to malfunction:
 - **High or extreme cold temperature area:**
under direct sunlight, near equipment that varies in temperature, in front of air-conditioner, inside a refrigerated area, etc.
 - **Places subject to moisture or humidity extremes.** 
 - **Places subject to environmental conditions,** such as oil, dust, chemicals, salt, etc.
 - **Places subject to constant vibration or impact.**

GENERAL PRECAUTIONS

1. The equipment, except the entrance station, is designed for indoor use only. Do not install them outdoors.
2. The system is not operable during a power failure.
3. In areas where broadcasting station antennas are close by, intercom system may be affected by radio frequency interference.
4. Keep all wiring at least 30cm, 1' away from AC100 ~ 240V wiring, fluorescent lighting, or dimmer switches. Otherwise, cross AC wiring at a 90° angle.









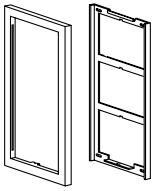
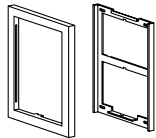
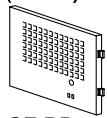
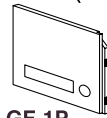
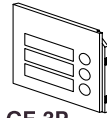

 **General Prohibitions**

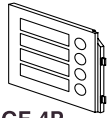
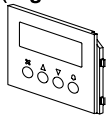
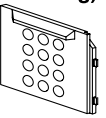
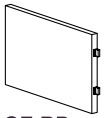
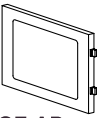
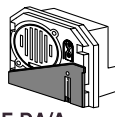
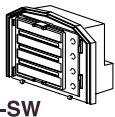
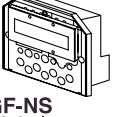
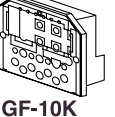
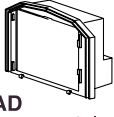
 **Prohibitions to subject the unit to water**

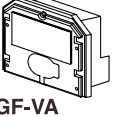
 **Prohibitions to dismantle the unit**

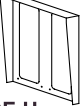
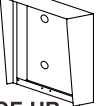
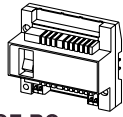
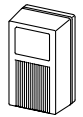
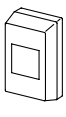
SYSTEM COMPONENTS

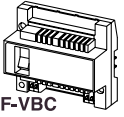
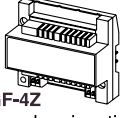
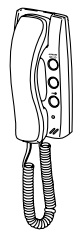
Entrance station

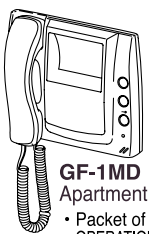
FRONT FRAME  GF-3F 3-module front frame • Mounting bracket • Packet of screws • Weather stripping (for reinforcement)		 GF-2F 2-module front frame • Mounting bracket • Packet of screws • Weather stripping (for reinforcement)	
PANEL (Audio)  GF-DP	(Full key)  GF-1P 1-call button panel  GF-3P 3-call button panel	 GF-2P 2-call button panel  GF-4P 4-call button panel	(Digital name scrolling)  GF-NSP  GF-10KP  GF-BP Blank panel  GF-AP Address panel
Note: GF-DA Audio Module is not compatible with GF-NS. Use GF-DA/A instead.			
MODULE  GF-DA/A Audio module • Connector	 GF-SW Call switch module • Directory card (plate & paper) • Connector	 GF-NS Digital name scroll module • Connector • OPERATION MANUAL	 GF-10K Digital keypad module • Connector
		 GF-AD Address module • Directory card (plate & paper) • Connector	Video Components  GF-VP  GF-VA Camera module • Connector
BACK BOX  GF-3B 3-module back box • Joint pipe (x 2) • Mounting gauge Do not discard.		 GF-2B 2-module back box • Joint pipe (x 2) • Mounting gauge Do not discard.	
		OPTION  GF-H Rain hood  GF-HB Hooded surface mount box • Each available for 2-and 3-module Panels in 1, 2 and 3 rows. GF-C 80cm (2'8") connecting wire	
Control units & power supplies			
 GF-BC Two-wire Bus control unit • INSTALLATION MANUAL • Special driver	 PS-2410LC (AC 120V) PS-2410LD (AC 220-240V) Power supply	 MAW-B Relay for entrance light (option)	 W-DIN11 (option) Mounting rail for GF-BC, VBC & 4Z
		 GF-VBC Video control unit	 GF-4Z 4-way bus junction unit
Apartment station			
 GF-1D Apartment station • Packet of screws • OPERATION MANUAL	DOORBELL BUTTON (option)  * not available from Aiphone		 GF-1MD Apartment station • Packet of screws • OPERATION MANUAL

MOUNTING ENTRANCE STATION

Panel combination examples

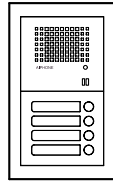

Audio, 4-call

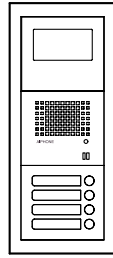

Audio/video, 4-call

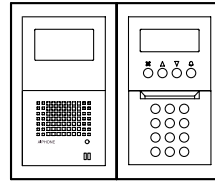

Audio/video with Digital name scrolling

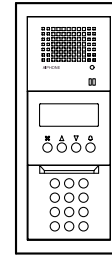

Audio with Digital name scrolling

Front frame & panels

Modules on bracket

Back boxes

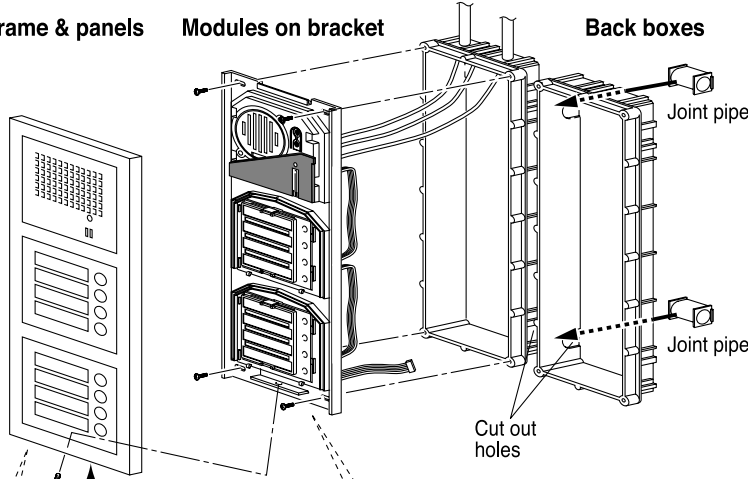

Do not cover water drainage holes with caulking seals.

Special driver (supplied w/GF-BC)
Mount front frame to the bracket,
tightening a screw at bottom.

ATTACH

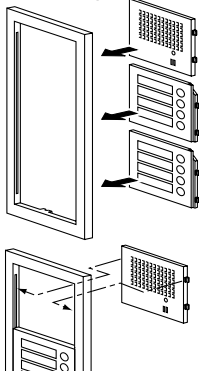

Assemble Panels of Audio
& Call SW. Modules into
front frame from the back.

Attach the Modules to
Mounting bracket to click.

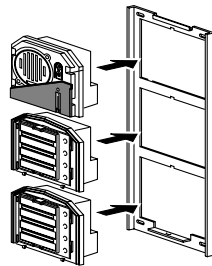

Options

• With rain hood

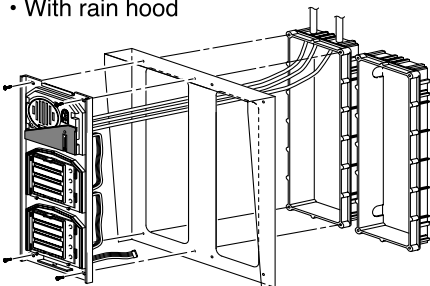

• With hooded surface mount box

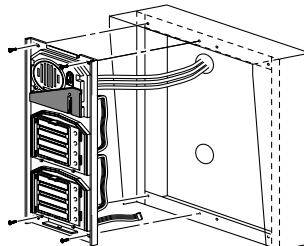

Mounting Back boxes

It is suggested to mount Camera module at the height of average adults' eye level. Allow a space of 2mm (3/32") or more on each side of back box in the wall.

EXAMPLES

• Two-module back boxes (x2)

Joint pipe (2)

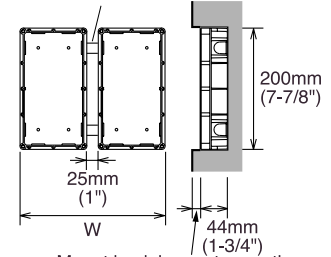

Mount back box not more than 15mm (1/2") in recess.

• Three-module back boxes (x3)

Joint pipe (ea.2)

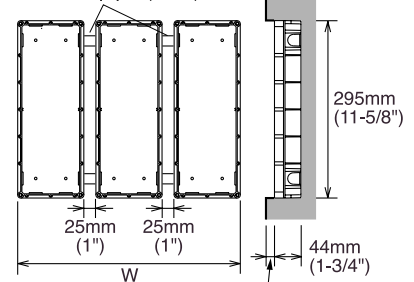

Mount back box not more than 15mm (1/2") in recess.

BACK BOX DIMENSIONS

• Module back boxes assembled

Back boxes	W (mm)	W (inch)
1 row	110	4-5/16"
2 rows	245	9-5/8"
3 rows	380	15"
4 rows	515	20-1/4"
5 rows	650	25-9/16"
6 rows	785	30-7/8"
7 rows	920	36-1/4"
8 rows	1055	41-9/16"
9 rows	1190	46-1/8"

For best results, the back box(es) must be mounted strictly horizontally.

MOUNTING ENTRANCE STATION

Interconnecting Modules with Plug-in Connectors

1 Remove the terminal cover.

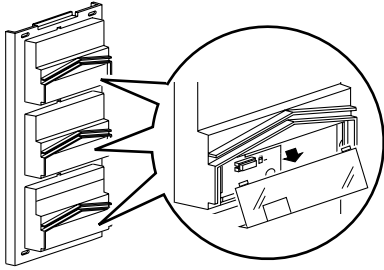

2 Plug the wires into connectors between the Modules.

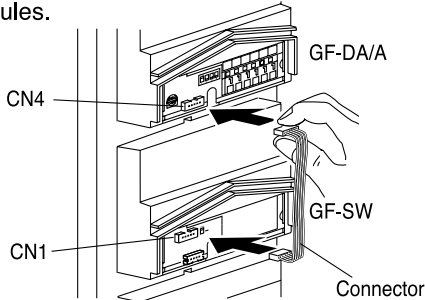

3 Plug the wires into connectors between the Modules.

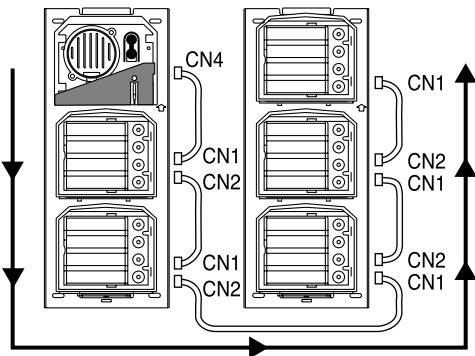

4 Pass the connecting wire through joint pipe (pre-opened), and plug to CN1 of Call SW. of next row.

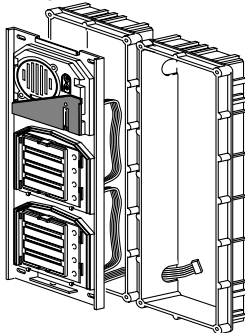

5 Attach the terminal cover back to place.

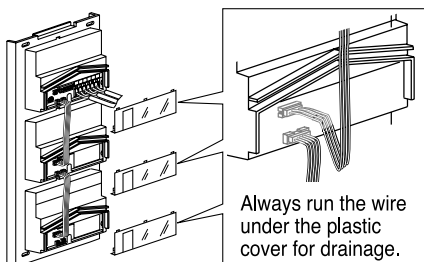

Examples

[1] When GF-VA Camera module is used;

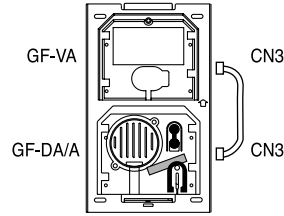

[2] When GF-NS/10K are used;

①

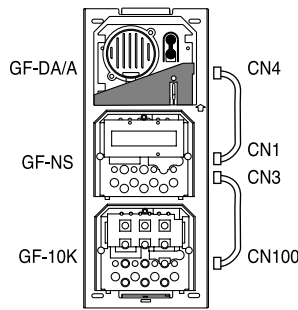

② When GF-AD Address module is used;

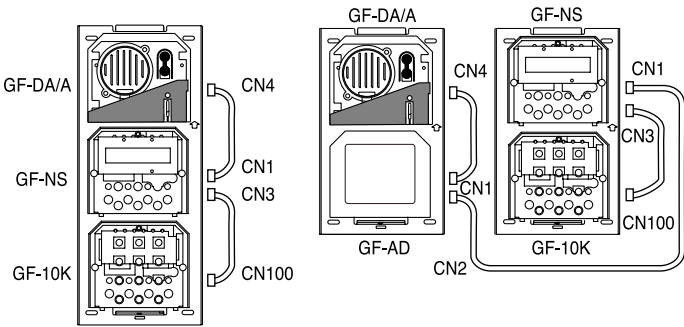

[3] When using GF-C;

In advance, pass a 80cm(2'8") long connecting wire (GF-C) through joint pipes.

① GF-VA, GF-DA/A, GF-AD, GF-NS, GF-10K

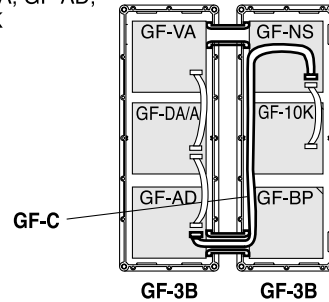

② Locating Audio module (GF-DA/A) in the middle row ;

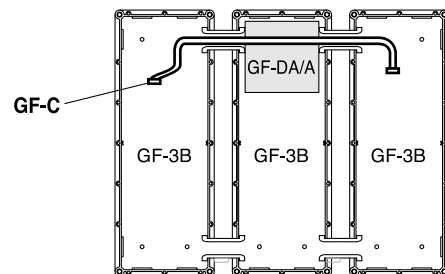

MOUNTING

• GF-BC, GF-VBC

GF-BC, GF-VBC

Screw (x2)

GF-BC,GF-VBC

Power switch
Power on LED (green)

Mounting rail for GF-BC, GF-VBC & GF-4Z: W-DIN11 available from Aiphone

Mounting rail

ON
OFF
Power switch
Green LED lit

HOW TO RESET BREAKER (Power switch)

When system malfunctions, check the wiring. Check the fuse of power supply. Turn off the power switch of GF-BC & GF-VBC and turn on after 4 seconds. Resets the whole system.

• GF-1D

It is suggested to mount the station at the height of 150cm (5') from the floor.

Service button
Handset
Light button
Door release button
Screw
Plug in
Modular plug
Cable inlet hole
Chassis
Single-gang box
83.5mm (3-5/16")
or round gang-box
60mm (2-3/8")

1. Loosen a screw on front case. Lift the front case off the chassis, and pull it away.
2. Mount chassis on box.
3. Connect incoming wires on terminal block.
4. Remount front case on chassis, tightening the screw.

Notes:

*1: Cut out a hole for surface cable run.

*2: Terminal block & switch for SERVICE button are optional.

*3: To avoid pinching, keep wires away from PC board section.

• GF-1MD

It is suggested to mount the station so that the video monitor comes at the user's eye level.

Handset
Plug in
Modular plug
Door release button
Light button
Service button
Mounting bracket
Screw
Single-gang box
83.5mm (3-5/16")
or round gang-box
60mm (2-3/8")

1. Attach the mounting bracket to single-gang box.
2. Connect wires, and remount terminal block.
3. Mount GF-1MD on mounting bracket.

Note;

To detach; Slide and pull out the terminal block.

Unplug

⚠ Strip jacket of cables, and put all the wires neatly into slot, otherwise damages the wires by pinching.

MOUNTING & WIRING

Audio communication system

SETTING (on GF-DA/A)

Entrance # SET switches

To set for Entrance stations #1 ~ 5, set DIP switches on Audio Module (GF-DA/A) as shown below. All the Entrance stations will malfunction if positioned in any other manner.

Entrance station

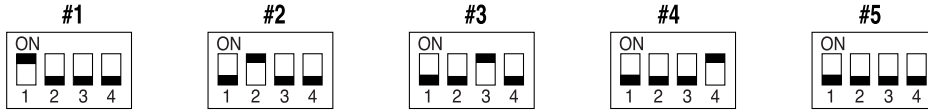

Door release timer

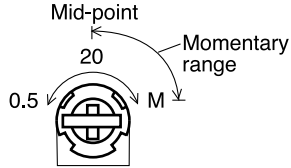

Shipped in "Momentary" position.

0.5	0.5 sec. duration;	Turn counterclockwise completely.
-	0.5 ~ 20 sec. duration;	Turn clockwise to obtain longer second of duration.
20	20 sec. duration;	Turn up to the mid-point.
M	Momentary activation(*);	Turn to any point between 20 - M.

(*) Activated as long as the door release button is held down.

Entrance station 1

Entrance station 2

GF-DA/A Audio Module

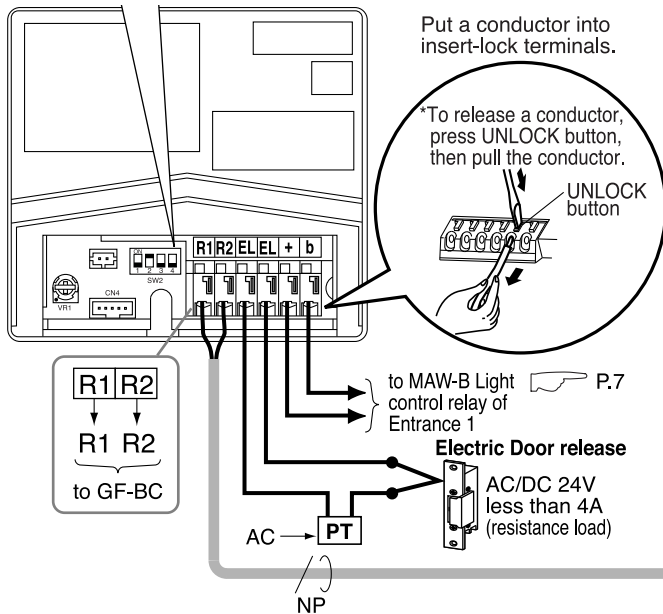

GF-DA/A Audio Module

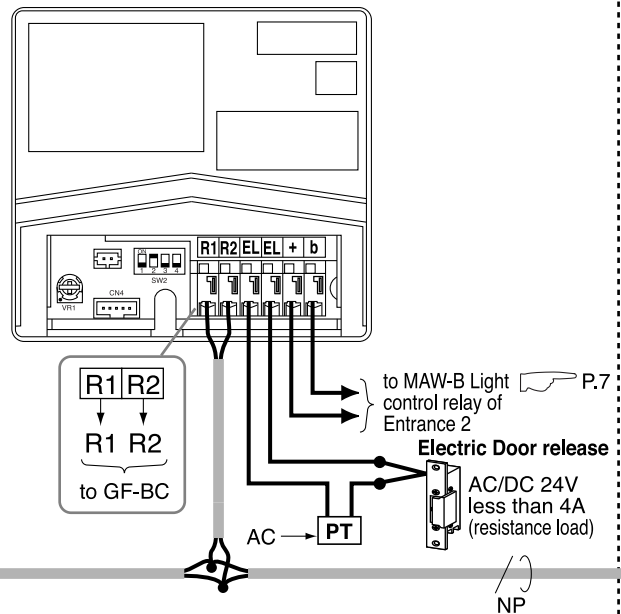

GF-NS Module

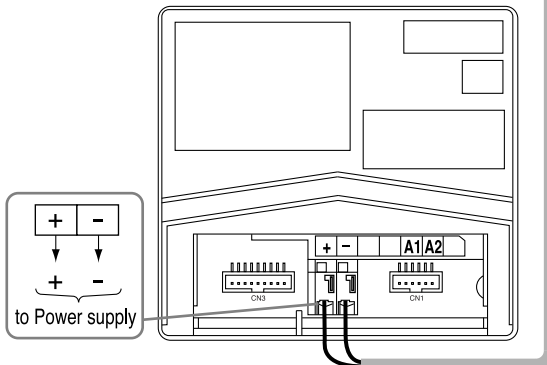

GF-NS Module

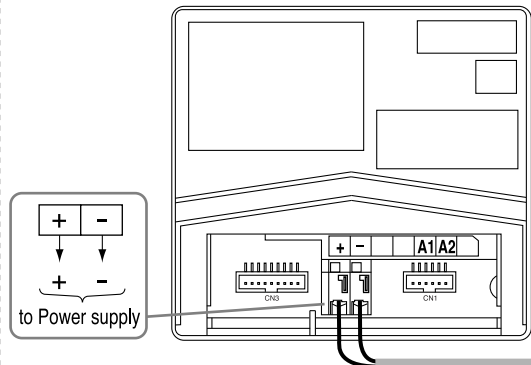

PT: AC transformer

NP: Non-polarized

Apartment station

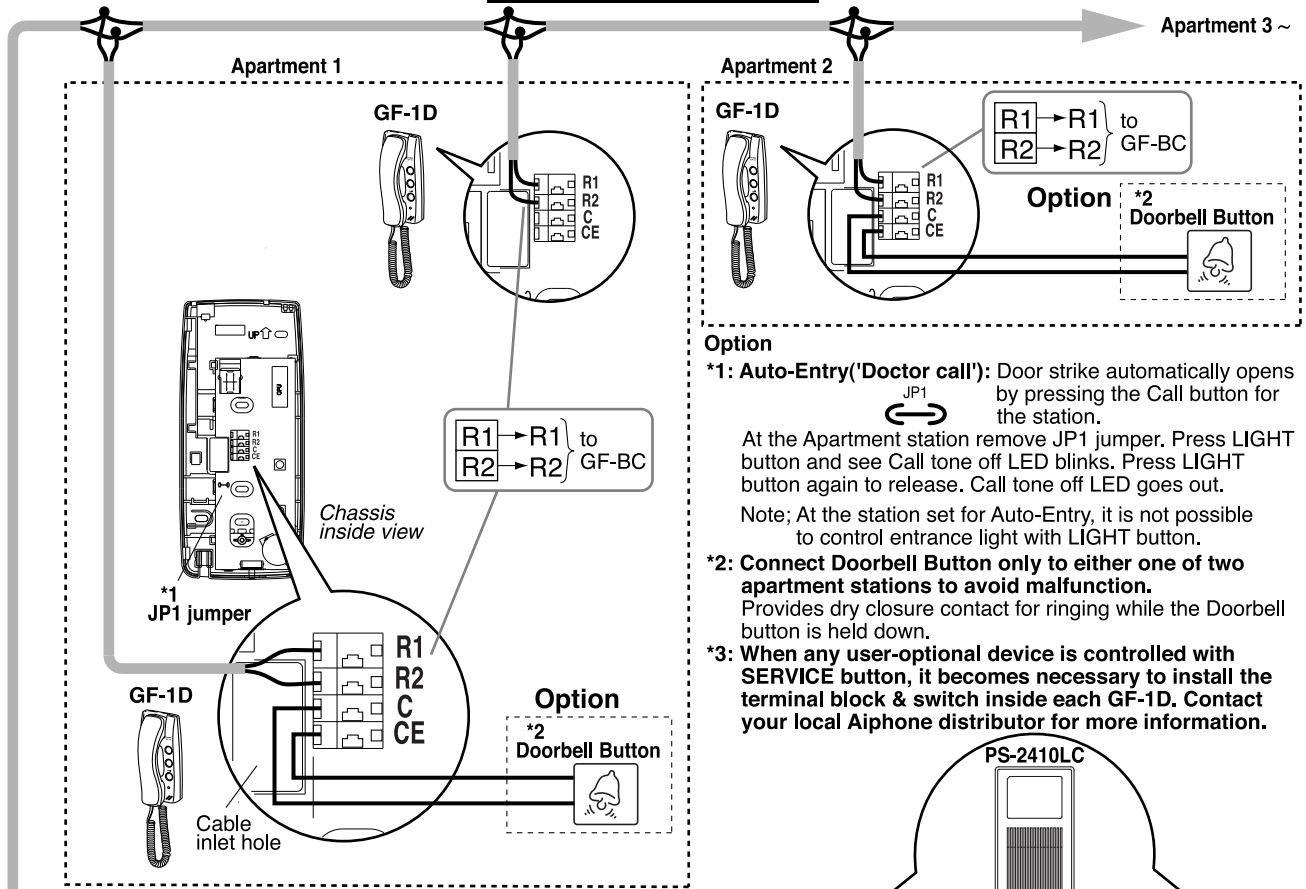

Option

- *1: Auto-Entry('Doctor call'):** Door strike automatically opens by pressing the Call button for the station.
 At the Apartment station remove JP1 jumper. Press LIGHT button and see Call tone off LED blinks. Press LIGHT button again to release. Call tone off LED goes out.
 Note; At the station set for Auto-Entry, it is not possible to control entrance light with LIGHT button.
- *2: Connect Doorbell Button only to either one of two apartment stations to avoid malfunction.** Provides dry closure contact for ringing while the Doorbell button is held down.
- *3: When any user-optional device is controlled with SERVICE button, it becomes necessary to install the terminal block & switch inside each GF-1D. Contact your local Aiphone distributor for more information.**

Control unit & Power supply

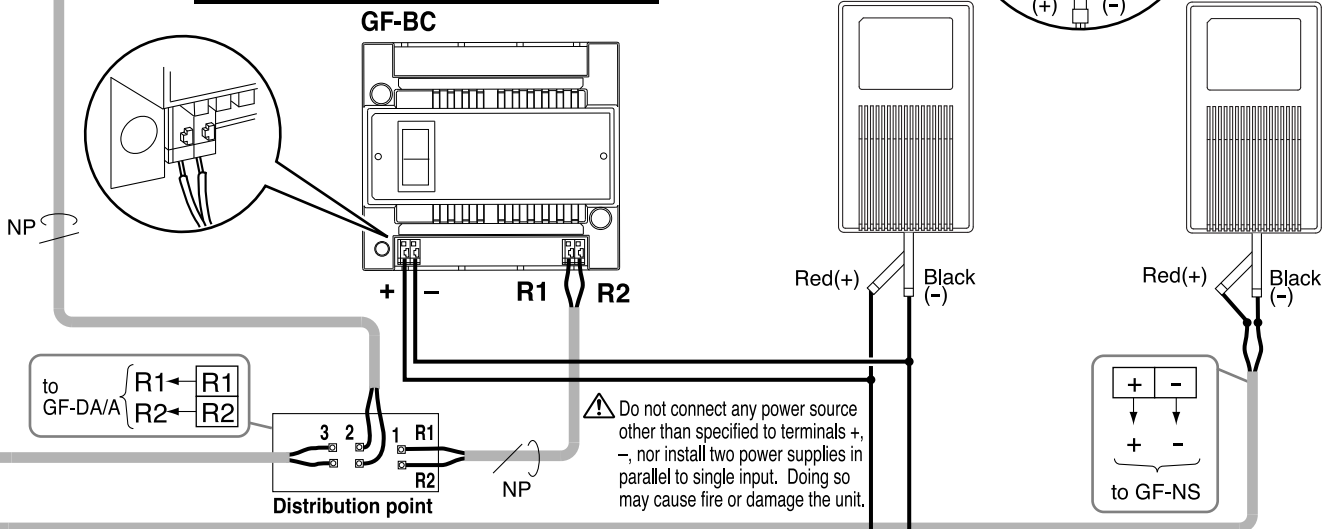

OPTION: Controlling Entrance light

For controlling light at the entrance, use Aiphone's MAW-B relay, which provides dry closure contact.

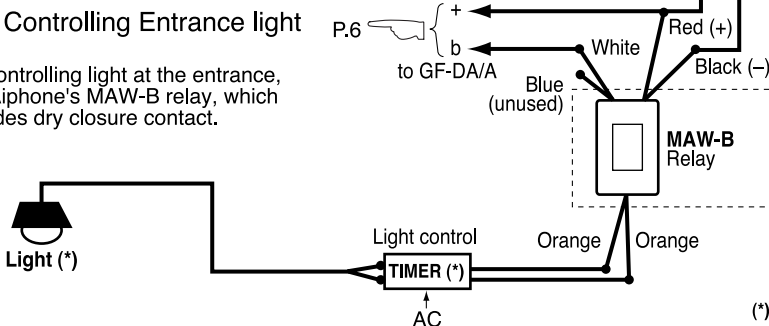

(*) Use light & timer locally available.

Audio/video communication system

Entrance station #1

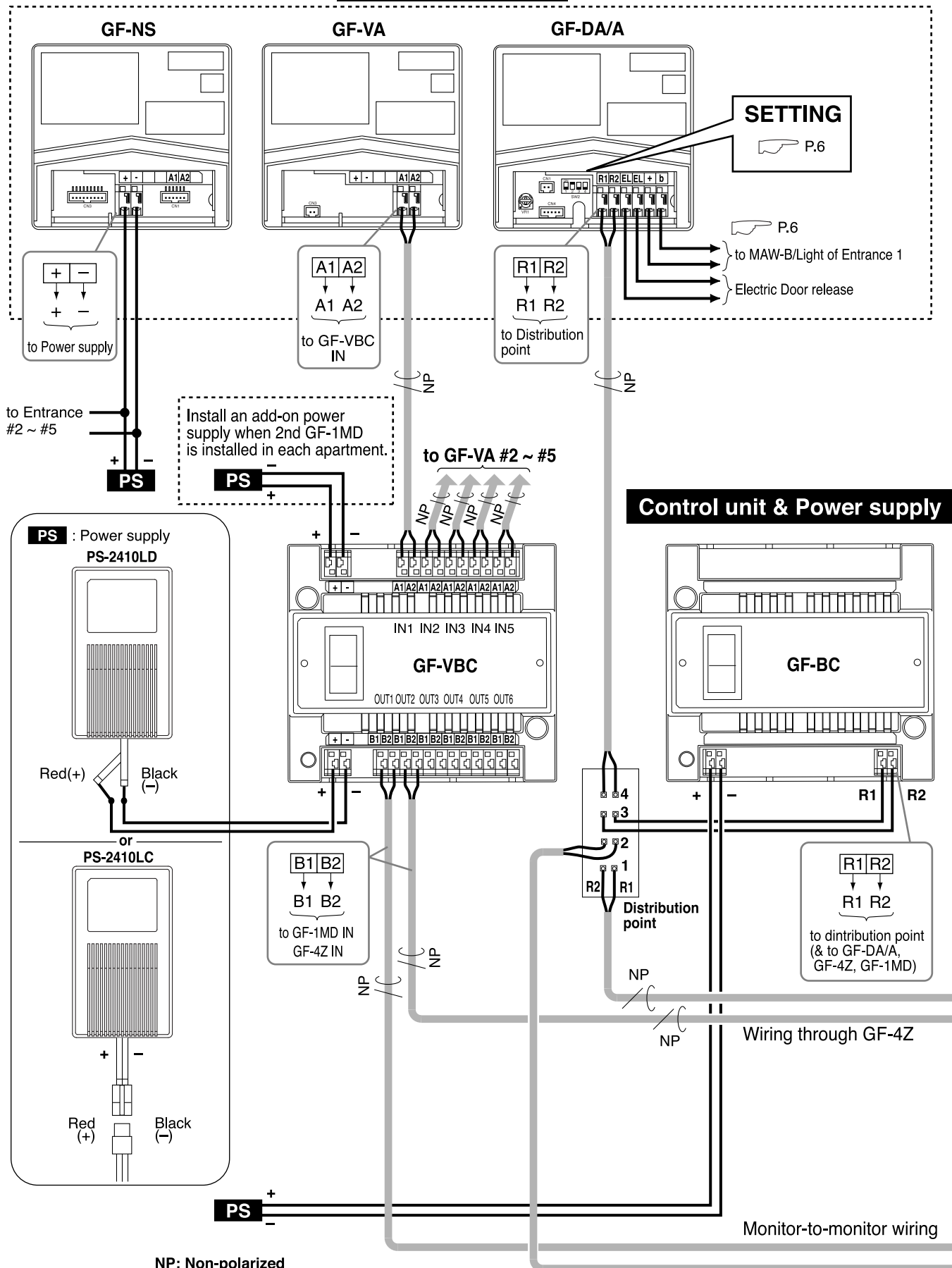

Apartment station

Wiring through GF-4Z 4-way bus junction unit

Monitor-to-Monitor wiring

Terminated

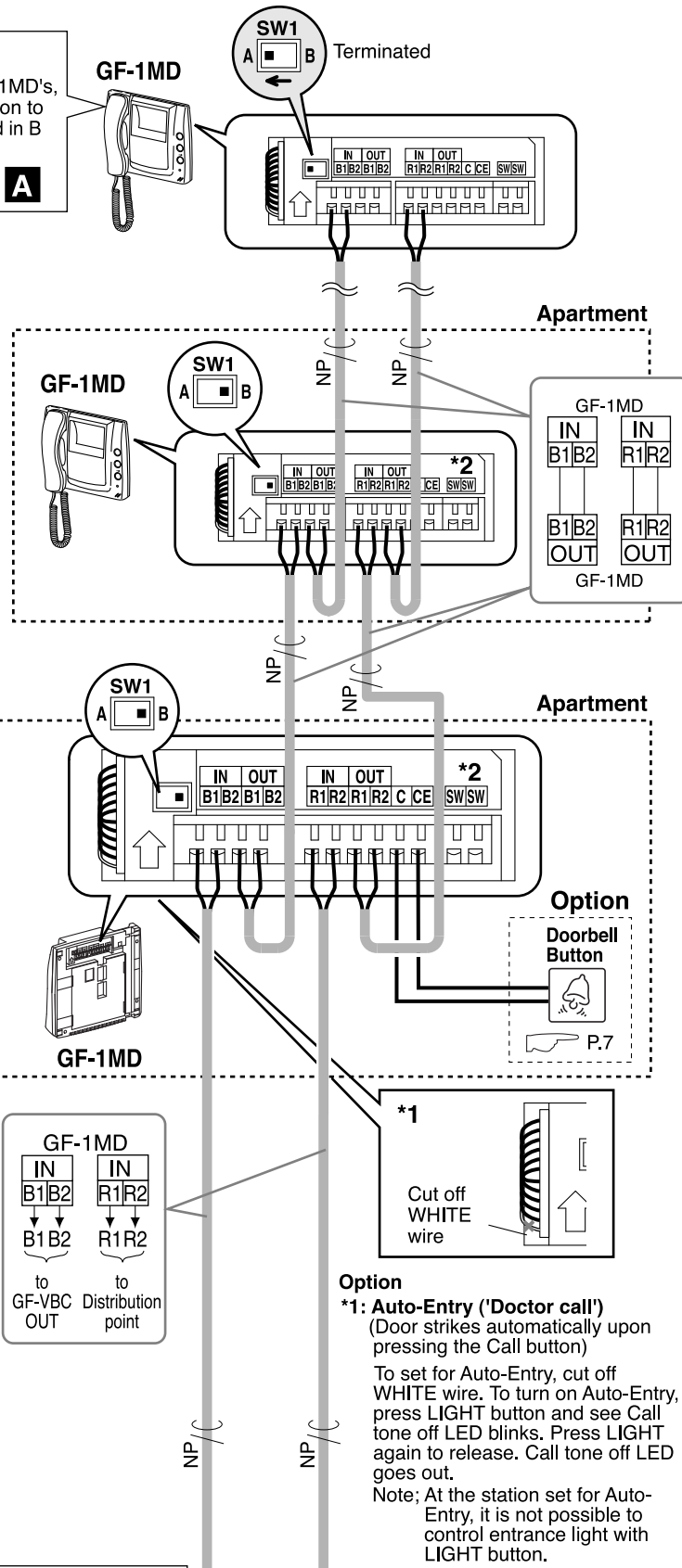
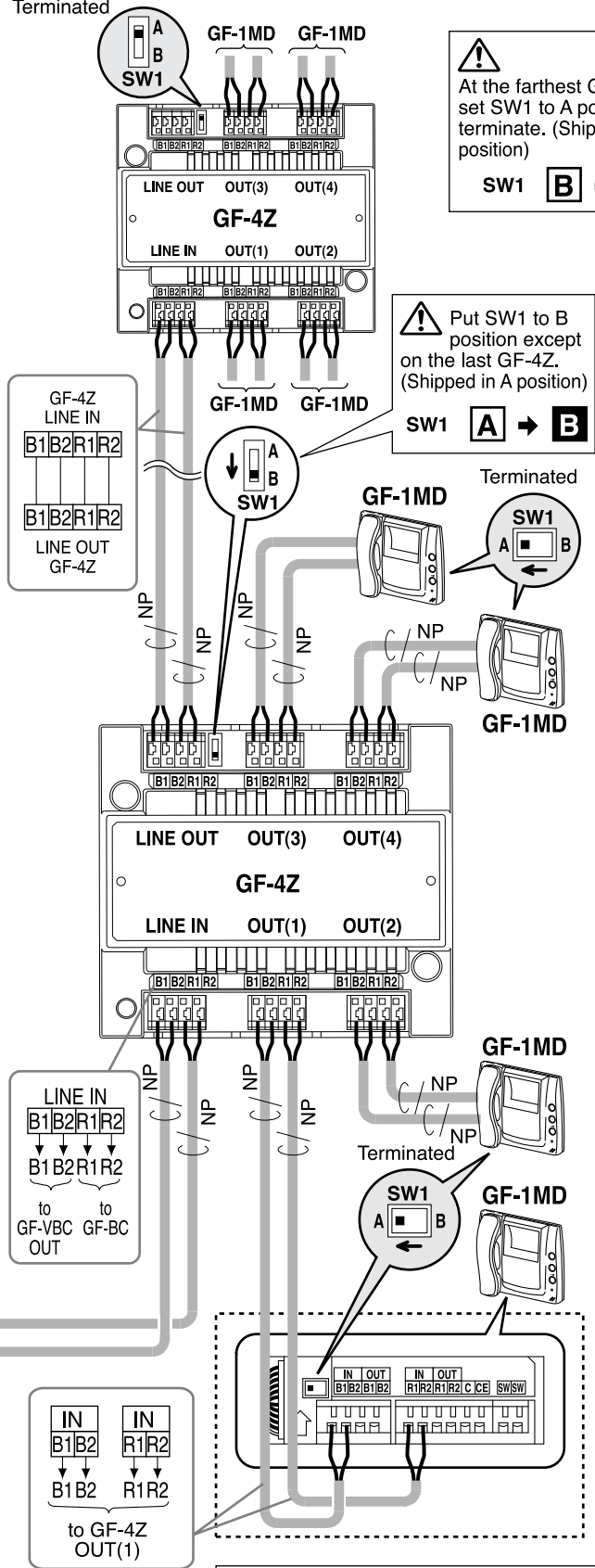

Option
***1: Auto-Entry ('Doctor call')**
 (Door strikes automatically upon pressing the Call button)
 To set for Auto-Entry, cut off WHITE wire. To turn on Auto-Entry, press LIGHT button and see Call tone off LED blinks. Press LIGHT again to release. Call tone off LED goes out.
 Note; At the station set for Auto-Entry, it is not possible to control entrance light with LIGHT button.

***2:** When any user-optional device will be controlled with SERVICE button, it becomes necessary to mount the terminal block & switch inside each GF-1MD. Contact your local Aiphone distributor for more information.

SETTING UP SYSTEM

Prior to setting up GF system, make sure all the stations are installed and wired in proper manner. Leave the front frame & module panels unattached.

Step 1 Press PROGRAM switch on GF-DA/A Audio Module.

Turn on power switch of GF-BC.

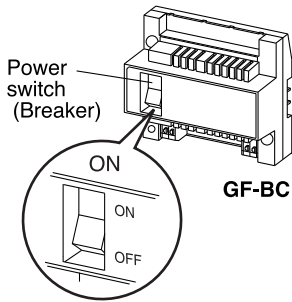

When front panels are already mounted, open unscrewing the bottom screw.

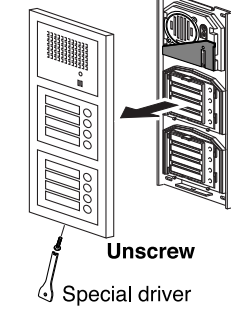

Open the rubber cap. Then push PROGRAM SW. momentarily.

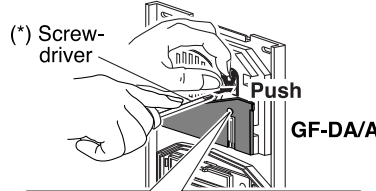

(*) Use any thin rod, such as fine screwdriver.

OPTION: SETTING FOR "LIGHT" button
(not available for GF-NS)

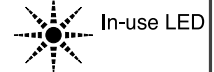

While In-use blinks (within 15 sec.), press an assigned call button.

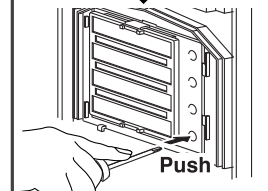

In-use LED
Starts to blink Is steadily lit.

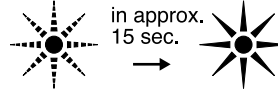

* The rest Entrance stations can not initiate programming.

Step 2 At an Apartment station #1, lift handset. Communication channel is established with Entrance station instantly. Hearing single BEEP tone means the station has been correctly set. Hang up handset.

Apartment station #1

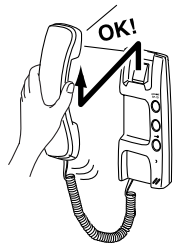

Entrance station
BEEP TONE

→ Call button 1 - Apartment 1 is linked.

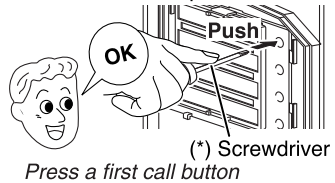

On Name scroll module

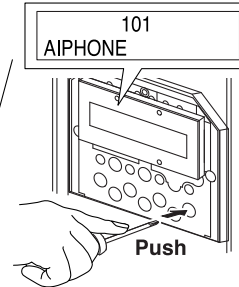

Have the assigned Name displayed, and press button.

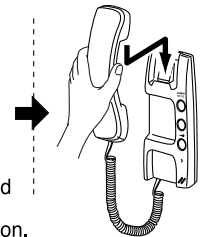

For a second station, if installed, lift second handset and press the same call button 1. Beep tone sounds twice.

Second Apartment station #1

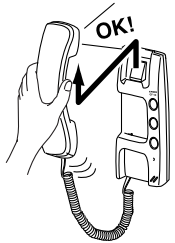

Entrance station
DOUBLE BEEP TONE

→ Call button 1 - Apartment 1 - 2 is linked.

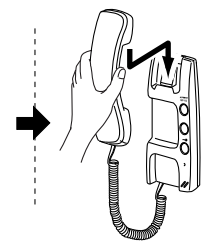
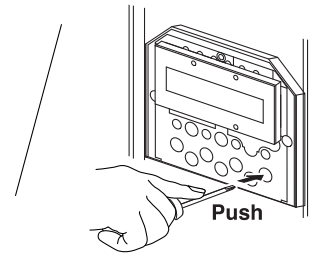
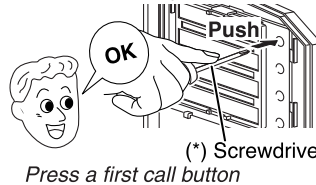

Step 3 Go to each apartment consecutively, and program each handset station in the same manner as in Step 2.

Step 4 When completed, press PROGRAM switch on GF-DA/A Audio module again to finish the programming.

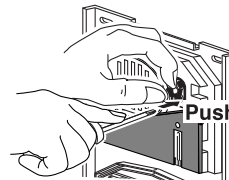

Do not forget to replace the rubber cap.

To correct wrong setting

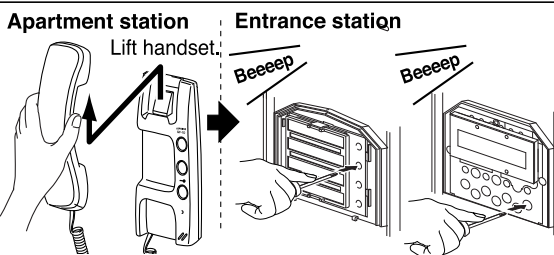

Keep pressing a call button to clear until a continuous tone is heard. (Consecutively, operate same way for next call button, if Following Step 2, reset on apartment station(s) that have been cleared.

For 2-station apartment

- Clearing a call button cancels programming for two stations, correctly set or not. Individually reprogram both stations.

Instructions

- (1) Before programming, connect Camera module, if included, with the other modules.
- (2) When Digital name scrolling module is included, be sure to program Residence info (Names & Room #) in advance.

ADJUSTING

Adjust camera angle

• Viewing from initial camera position

• Changing camera angle

• Image view area

1. Open the rubber cap.
2. Change the camera angle with the lever.

* Do not forget to replace the cap.

Fill in name & address; Peel off film

Fill in directory or address on the transparent plate with an oil-soluble pen, etc. and attach the plate to module.

Plate (*) or paper

Pressing on either side, remove directory plate or paper.

Call SW. module

(*) LCD display

Digital name scroll module

Plate (*) or paper

Pressing on either side, remove address plate or paper.

Address module

(*) Before mounting the panel, peel off film.

Adjust, using the mounting gauge

After wiring & setting, mount the module-mounted bracket to back box. Finally, attach front frame/panel to the bracket.

Mounting bracket

Adjustable screw holes

Special driver

When mounting multiple rows of panels, attach the mounting gauges and tighten screws on the brackets.

Mounting gauge

ATTACH

TIGHTEN

Mounting gauge

Mounting gauge: Supplied with GF-2B, GF-3B Built-in back box.

TECHNICAL PRECAUTIONS

- Temperature** GF Entrance station: -10°C ~ +60°C (+14°F ~ +140°F).
GF-BC: 0°C ~ +40°C (+32°F ~ +104°F). GF-1D: 0°C ~ +40°C (+32°F ~ +104°F).
- Mounting location** Do not install the Entrance station in places where a caller is strongly backlit (bright background), or where sunlight or strong light comes into the camera lens directly.
- Rain hood (option)** GF Entrance station is weather-resistant, but for best results, it should be protected from direct weather conditions. Install a rain hood (GF-H) to protect it from direct rainfall.
- Set up after replacement** In case an apartment station is replaced after all the wiring is done, turn the power switch off and back on again on GF-BC. Then reprogram that apartment station only.
- Operations**
 - At end of communication, hang up the handset on cradle. If a handset is off the hook, call tone will still ring at two stations. Momentarily hang up handset, and resume communication.
 - While an apartment station is being called from an entrance station, a call from the doorbell will not be heard.
- Cleaning**
 - Clean GF equipment with a soft cloth dampened with neutral household cleanser.
 - Never use any abrasive cleaner or cloth.
 - Do not spray high-pressure water on Entrance station.

SPECIFICATIONS

- **Power source:** DC 24V (each GF-BC, GF-VBC & GF-NS), supplied by a power supply PS-2410LC or PS-2410LD.
- **Current consumption:** GF-BC: 0.9A. GF-VBC: 1.1A. GF-NS: 0.07A.
- **Call-in tone:** Two types of call tones, one from entrance station, the other from doorbell button, distinguishable.
- **Talk path:** Single channel, non-open.
- **Communication:** Simultaneous with handset (no calling or communication between apartment stations).
- **Wiring:** 2 x 2-wire cables solid.
- **Type of Cable:** 2-conductor cable solid copper & non-braided, polyethylene insulation, 0.65mm dia. ~ 1.0mm dia. (22AWG ~ 18AWG).

• **Wiring distance:**

Diameter of wires	0.65mm	0.8mm	1.0mm	22AWG	20AWG	18AWG
• GF-BC to Distribution point	-	5m	-	-	16'	-
• Distrib. point to Entrance station	-	300m	-	-	980'	-
• Distrib. point to GF-1D (farthest)	-	300m	-	-	980'	-
• GF-VBC to farthest GF-1MD 1 per resid. line	100m	150m	-	330'	500'	-
• GF-VBC to farthest GF-1MD 2 per resid. line	50m	100m	150m	165'	330'	500'
• GF-VBC to Entrance station (GF-VA, Video)	50m	100m	-	165'	330'	-
• GF-BC/VBC to ea. Power supply	-	5m	5m	-	16'	16'
• GF-NS to Power supply	-	300m	300m	-	980'	980'
• MAW-B to Entrance station	-	300m	-	-	980'	-
• Total wiring distance (R1, R2)	-	2.5km	-	-	1.5miles	-

• **Capacity:**

• Total station:	250 residential stations
• Total monitor station:	150 GF-1MD's
• Entrance station:	5 (audio or video)
• Per apartment:	2 stations (GF-1MD and/or GF-1D)
• Max. station per trunk line:	50 GF-1D's, 25 GF-1MD's, (i.e. via 6 GF-4Z's or monitor-to-monitor wiring).
• Video trunk line:	6 (Video) from GF-VBC.
• Audio trunk line:	Any number (Audio) from distribution point.
• Max. Entrance station per trunk line:	Max. 3 Entrance stations (Audio)
• Call button:	100-call, i.e. 25 pcs GF-SW.

• **Dimensions & weight**

Models	H x W x D (mm)	Weight (approx.)	H x W x D (inch)	Weight (approx.)
• GF-1MD	210 x 215 x 69	1,200g	8-1/4" x 8-1/2" x 2-3/4"	2.65 lbs.
• GF-1D	200 x 89 x 63	370g	7-7/8" x 3-1/2" x 2-1/2"	0.82 lbs.
• GF-BC	108.5 x 122.5 x 61	450g	4-1/4" x 4-13/16" x 2-3/8"	1 lb.
• GF-VBC	108.5 x 122.5 x 61	260g	4-1/4" x 4-13/16" x 2-3/8"	0.57 lbs.
• GF-4Z	108.5 x 122.5 x 61	190g	4-1/4" x 4-13/16" x 2-3/8"	0.42 lbs.
Entrance station				
• 2-module, 2-row panel	225 x 270 x 16 (box: 44 in recess)	-	8-7/8" x 10-5/8" x 9/16"	-
• 3-module, 1-row panel	320 x 135 x 16 (box: 44 in recess)	-	12-1/8" x 4-7/8" x 9/16"	-

• **Door release terminals:**

EL, EL rated less than 4A (resistance load), AC/DC 24V, for dry closure contact for door release.

This equipment has been tested and found to comply with the limits for a Class B digital device, pursuant to Part 15 of the FCC Rules. These limits are designed to provide reasonable protection against harmful interference in a residential installation. This equipment generates, uses, and can radiate radio frequency energy and, if not installed and used in accordance with the instructions, may cause harmful interference to radio communications. However, there is no guarantee that interference will not occur in a particular installation. If this equipment does cause harmful interference to radio or television reception, which can be determined by turning the equipment off and on, the user is encouraged to try to correct the interference by one or more of the following measures:

- Reorient or relocate the receiving antenna.
- Connect the equipment into an outlet on a circuit different from that to which the receiver is connected.
- Increase the separation between the equipment and receiver.
- Consult the dealer or an experienced radio/TV technician for help.

WARRANTY

- Aiphone warrants its products to be free from defects of material and workmanship under normal use and service for a period of one year after delivery to the ultimate user and will repair free of charge or replace at no charge, should it become defective upon which examination shall disclose to be defective and under warranty. Aiphone reserves unto itself the sole right to make the final decision whether there is a defect in materials and/or workmanship; and whether or not the product is within the warranty.
- This warranty shall not apply to any Aiphone product which has been subject to misuse, neglect, accident, or to use in violation of instructions furnished, nor extended to units which have been repaired or altered outside of the factory.
- This warranty does not cover batteries or damage caused by batteries used in connection with the unit.
- This warranty covers bench repairs only, and any repairs must be made at the shop or place designated in writing by Aiphone.
- Aiphone will not be responsible for any costs incurred involving on site service calls.

AIPHONE CO., LTD., NAGOYA, JAPAN
AIPHONE CORPORATION, BELLEVUE, WA, USA
AIPHONE EUROPE N.V., ANTWERP, BELGIUM

 **AIPHONE**®
Providing Peace of Mind
<http://www.aiphone.com/>
Printed in Thailand (E)